

JVC

4K Super 35 Camera Recorder

GY-LS300CH

Express your artistic vision



4K CAM

Shown with optional lenses and accessories

Cinematic Talents

Compact, convenient, and ultra high definition, JVC's GY-LS300CH is equipped with a 4K Super 35 CMOS sensor and uniquely accommodates a wide range of cinema and photographic lenses and adapters for dazzling cinematic effects. Harness the full power of 4K Ultra HD including 4K 4:2:2 sampling, and 4K 60/50p Output. Stay connected with SD and web friendly proxy formats, or even stream live HD over the internet while recording full HD. No other removable lens video camera offers this much flexibility in such a compact, easy-to-handle form factor. For quality, performance and ergonomics that let you keep on going, count on JVC's GY-LS300CH from the first shot to the final cut.



4K CAM

[Super 35 CMOS 4K Image Sensor]

The GY-LS300CH features a 4K CMOS Super 35 image sensor—a premium solution for uncompromised cinema production, ultra-clear broadcast video, as well as full resolution 4K video. This large sensor delivers a superior dynamic range, high S/N ratio and high sensitivity, contributing artistic visual expression including shallow depth of field “bokeh” effects.

Super
35mm

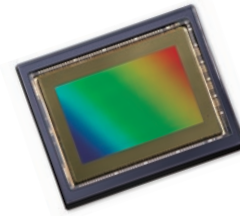

[Micro Four Thirds (MFT) Lens Mount]

Super 35 sensor and Micro Four Thirds (MFT) lens mount provide a balance of high-end cinematic imagery and affordable glass. Dozens of high quality Micro Four Thirds lenses* are readily available and require no adapter. Thanks to the short flange focal distance (slightly less than 20mm) most cinema lenses can be adapted for use, whether PL mount or Canon EF mount. The mount’s electrical connections are compatible with many auto focus, iris and power zoom lenses—even when using an adapter. One important difference from most Micro

Four Thirds cameras is that the GY-LS300CH uses a Super 35 imager—approximately 35% larger than a standard MFT imager. JVC’s mount provides full coverage of the imager so Super 35 lenses may be used without vignetting. In fact, a number of S35 lenses are available that do not require an adapter. For the professional on a budget, having a camera this versatile can literally save thousands of dollars in lens purchases.

*More detail of supported lenses will be informed on JVC website.



Optional MFT lenses



Optional adapters (Metabones®) for PL and EF lenses

OLYMPUS

[Variable Scan Mapping]

You can use a variety of Super 35, MFT or Super 16 lenses with ease. That’s because Variable Scan Mapping (VRSM) intelligently remaps the pixels on the sensor chip in accordance with the native field of view of the lens so that the pixels fill the entire picture frame—thereby eliminating vignetting. And that means professional cinematographers

can actually use high-end, large format cinema 35 lenses on a handheld camera that will correctly frame those lenses. The images below illustrate how VRSM maximizes the pixels on the sensor chip to accommodate common lens sizes and maintain their original field of view.

■ JVC Exclusive Variable Scan Mapping Eliminates Vignetting

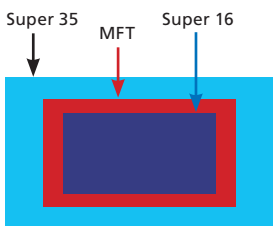

Scan Mapping can be adjusted to accommodate any lens eliminating vignetting while maintaining the original FOV (Field of View).

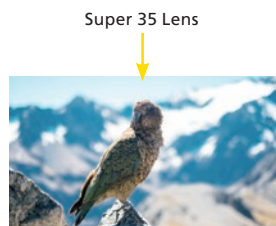

A Super 35 lens records just as the image would appear on Super 35 film.

MFT Scan — The recorded image when VRSM is set to MFT

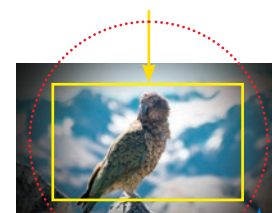

MFT “Image Circle” Vignetting eliminated from recording

Super 16 Scan — The recorded image when VRSM is set to Super 16

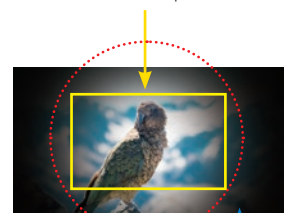

S16 “Image Circle” Vignetting eliminated from recording

[Prime Zoom with Variable Scan Mapping]

Prime lenses have a fixed focal length, but the GY-LS300CH’s Prime Zoom features takes advantage of JVC’s unique variable scan mapping which allows you to dynamically map the pixels on the image sensor to your target output resolution. When used with an MFT prime lens, the image can be adjusted between the maximum scan area and minimum scan area using the camera’s zoom lever, allowing you to use a fixed focus lens as a maximum 1.2x (4K) or 2.3x (HD) zoom lens.



Non-zoom image



2.3x Prime Zoom image



Stellar 4K Performance

**4K 60/50P
OUTPUT**



Shown with optional lens and accessories

[4K/Ultra HD (UHD) Recording at 150Mbps and Live Output]

Working with 4K has never been easier. Insert an SDHC or SDXC (UHS-I Speed class 3) memory card and record hours of 4K/UHD (3840x2160) material. Recordings are made using the Quicktime (.MOV) file format and are compatible with many popular editing systems. Connect a 4K/UHD monitor with a single HDMI cable, and view the camera's live 4K signal. You can also play back recorded files directly from the camera. The GY-LS300CH also downconverts UHD signals to standard HD for output through the built-in SDI or HDMI connectors.

[4K (UHD) 60/50P HDMI Output and Recording Solution]

The GY-LS300CH can output UHD (3840x2160) at 60/50p via its HDMI port. What's more, JVC's partnership with Atomos means the GY-LS300CH operates seamlessly with the new Ninja Inferno and Shogun Inferno monitor recorders, triggering recording from the camera's start/stop operation. Plus, when the camera is set to J-Log 1 gamma recording mode, the Atomos units will record the HDR footage and display it on their integrated, seven-inch monitors.

[4K (UHD) 4:2:2 Recording]

Compared to typical 4:2:0, the ability to record 4K (UHD) 4:2:2 30/25/24p at 150Mbps/70Mbps makes the GY-LS300CH an ideal camera for broadcasting and cinematic production houses alike. The color accuracy of 4:2:2 enables the GY-LS300CH to deliver exceptional color resolution even when images are in sharp contrast to the background which is particularly useful when strong colors are in contrast to bright backgrounds or in green screen uses. Full HD 4:2:2 60/50p recording at 50Mbps also possible.

[JVC Log Gamma (J-Log 1)]

JVC Log mode delivers wide latitude and high dynamic range—up to 800 percent—to create images that truly rival the look of film. By preserving more information over the entire dynamic range and wide color gamut of the Super 35 sensor, log images will look flat and lack contrast but contain more information for grading and manipulation in post production giving you the opportunity to create truly stunning, cinematic results.

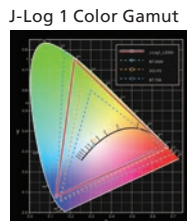
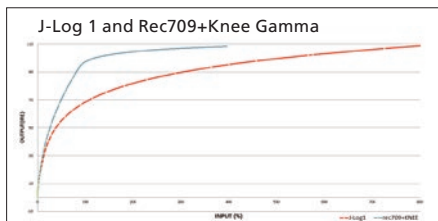

[More Manageable 70Mbps 4K Recording Mode]

In addition to the 150Mbps 4K recording mode, a 70Mbps mode is available to record 4K footage on economical Class 10 SDHC/SDXC memory cards. The lower bit rate creates smaller, more manageable files.



Shogun Inferno



Ninja Inferno

**4K (UHD) 4:2:2 30p/25p/24p
at
150Mbps/70Mbps**

Example:

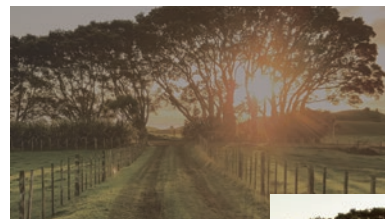

J-Log image looks flat but contains more information for post processing.

After color grading and processing, image is rich and vibrant.



[120fps (59.94Hz)/100fps (50Hz) High-Speed Recording for Slow Motion Playback]

Also available is high-speed recording* at up to 120fps (59.94Hz)/100fps (50Hz) for smooth slow motion playback (Up to 1/5 slow at 24p mode). It helps create artistic effects and lets you watch replays to examine sporting skills.

*Available in 1920x1080 resolution only

[Cinema 4K and Cinema 2K Recording]

For the ultimate cinema look, record images in Cinema 4K (4096x2160) at 150 or 70Mbps, or Cinema 2K (2048x1080) at 50Mbps each with a 17:9 aspect ratio for digital cinema presentations. Both modes support recording in 23.98p or true 24p to match the frame rate of film.

Usability, Reliability, Cost-Performance



Shown with optional lens

[Dual SDHC/SDXC Card Slots]

Dual card slots make the GY-LS300CH a truly versatile camcorder, offering such benefits as simultaneous recording, backup recording, and relay recording. In relay recording, you can shoot continuously and seamlessly over multiple cards. When one card is full, the camera switches seamlessly and automatically to the other card.



Dual slots

■ Usable SD Card for Each Format

System	Format	Bit rate	Usable SD card
High-Speed		50Mbps (XHQ) 35Mbps (UHQ)	UHS-I U3 or higher*
		150Mbps (YUV422) 150Mbps	
4K	QuickTime	150Mbps	Class 10 or higher
C4K		150Mbps	
4K		70Mbps (YUV422) 70Mbps	
C4K		70Mbps	
4K		50Mbps (YUV422) 50Mbps (XHQ)	
C2K		50Mbps (YUV422) 50Mbps (XHQ)	
HD	AVCHD	50Mbps (YUV422) 50Mbps (XHQ)	Class 6 or higher
		35Mbps (UHQ)	
SD	—	—	Class 4 or higher
Web	—	—	

*Also requires Class 10 or higher

[XLR Audio Inputs and Built-in Stereo Microphone]

Equipped with 2 channels of XLR Audio inputs in addition to the built-in stereo microphone. MIC/LINE switching is quick and easy.

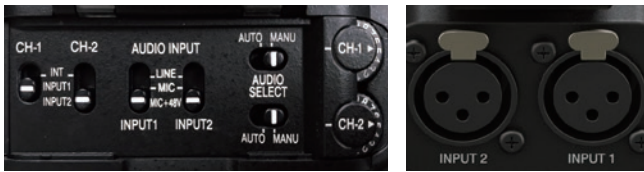

[Various Shooting Assist Functions]

• Histogram Display

Useful for checking image exposure by showing brightness distribution, enabling you to avoid blown out highlights and blocked up shadows.

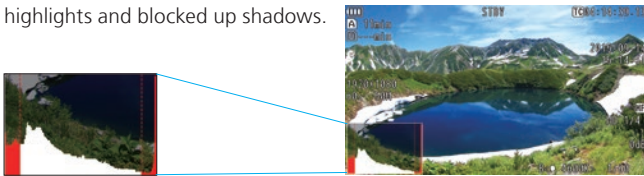

• Spot Meter

Displays the brightness of the subject when recording. Just move the cursor to the part of the screen you want to measure. Make your exposure decisions based on live data.



• Focus Assist

With this function, the focused area is displayed in color, enabling easy and accurate focusing.

[Advanced IP Network Communication and HD Streaming*1]

The GY-LS300CH features JVC's latest IP communications engine, giving you remote control and monitoring from a tablet, smartphone, or computer anywhere in the world. Control functions include lens (zoom, focus, iris) and camera settings (gain, shutter, WB, paint, LoLux, etc.) and those are possible even during 4K/UHD 30p/25p/24p*2 recording. Live streaming is possible in HD or lower resolutions, depending on available bandwidth. JVC's Advanced Streaming Technology (AST) includes Zixi powered Forward Error Correction (FEC) with ARQ, delivering high quality streams even under challenging conditions. And GY-LS300CH supports SMPTE2020-1, which is FEC for real-time video/audio transport over IP network. Connect your GY-LS300CH to an optional Wi-Fi or 4G/LTE modem and share your program with an audience anywhere in the world via content delivery networks such as USTREAM, YouTube and JVC VIDEOCLOUD. Uploading recorded 4K/HD files to an FTP server is also possible.

*1 Requires appropriate network connection and adapter

*2 Not available during 4:2:2 recording (4K/HD)



[Built-in ND Filter]

There's no need for an external ND filter. 1/4, 1/16, 1/64 selectable for instant adjustment of light intake.

[Pre Rec Mode]

When set to this mode, the scene gets recorded up to 15 seconds before you press the REC button. Ideal for situations where the action is not scripted and you don't want to miss the critical moment. (5 sec. in 4K, 5/10/15 sec. in HD)

Dimensions

Unit: mm (inch)

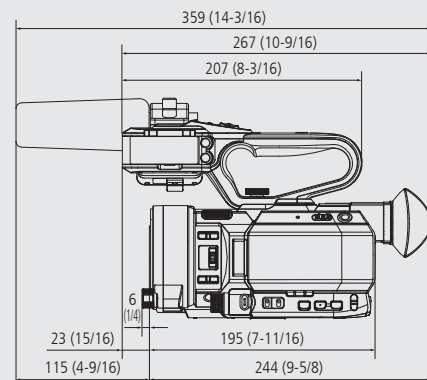
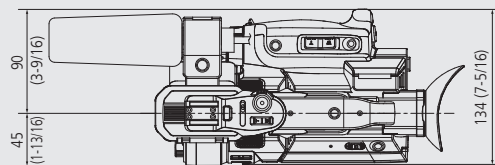
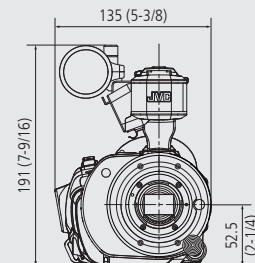

Specifications

GENERAL SPECIFICATIONS	
Power	DC 12V (AC adaptor), DC 7.4V (battery)
Power consumption	Approx. 9.8W (HD) (with VF in REC mode, default setting)
Weight	Approx. 1.7kg (3.75lbs) (including battery)
Dimensions	135(W) x 191(H) x 359(D)mm
Operation temperature	0°C to 40°C (32°F to 104°F)
Storage temperature	-20°C to 50°C (14°F to 122°F)
Operating humidity	30% to 80%
Storage humidity	Under 85%
CAMERA	
Image sensor	Super 35 13.5 M pixels progressive scan CMOS
Synchronizing	Internal synchronization
Lens mount	Micro Four Thirds system mount
Shutter speed	U model: 1/6 – 1/10000 E/EC model: 1/4 – 1/10000
Gain	0, 3, 6, 9, 12, 15, 18, 21, 24 dB, LoLux (30,36 dB), AGC
ND filter	None, 1/4, 1/16, 1/64
LCD display	3.5-inch 920 k pixels, 16:9
Viewfinder	0.24-inch LCOS 1.56 M pixel, 16:9
VIDEO/AUDIO RECORDING	
Recording media	2x SDHC/SDXC memory card (4K (150Mbps): UHS-1 U3 4K (70Mbps), HD: 50Mbps Class 10, HD: 35Mbps Class 6, AVCHD/SD Class 4)
Video recording	Video codec: MPEG-4 AVC/H.264 (4K/HD/SD/Proxy), AVCHD (HD/SD) File format: MOV (H.264), MTS (AVCHD)
Audio recording	LPCM 2ch, 48kHz/16-bit (4K/HD/SD MOV), AC3 2ch (AVCHD), μ -law 2ch (Proxy)
LIVE VIDEO STREAMING	
Protocol	RTMP, MPEG2-TS/UDP, RTSP/RTP, RTP, ZIXI
Bit rate	0.3 – 12 Mbps
Resolution	1920x1080, 1280x720, 720x480, 480x270
INTERFACE	
Video output	SDI output (BNC x1) HDMI output x1 AV output (ϕ 3.5mm mini jack x1)
Audio input	XLR x2 (MIC, +48V/LINE), ϕ 3.5mm mini jack x1
Audio output	AV output (ϕ 3.5mm mini jack x1)
Headphone	ϕ 3.5mm mini jack x1
Remote	ϕ 2.5mm mini jack x1
USB	HOST x1 (Network Connection), DEVICE x1 (Mass storage) Supported devices: 4G LTE modems, Wi-Fi and LAN adapters
Network function	Supported devices: 4G LTE modems, Wi-Fi and LAN adapters Live Video Streaming, FTP, Remote Control
ACCESSORIES	
Included accessories	Handle unit, battery (SSL-JVC50) x1, AC adapter x1, microphone x1

Recording Formats

System	Format	Resolution	Frame rate	Bit rate	Audio	Rec time on 64GB SD Card	
C4K	QuickTime (MPEG-4, AVC/H.264)	4096x2160	24p/23.98p	150Mbps/70Mbps	LPCM 2ch 48kHz/16bit	50 min./105 min.	
		3840x2160	29.97p/25p/23.98p	150Mbps/70Mbps (YUV 4:2:2/Normal)			
C2K	QuickTime (MPEG-4, AVC/H.264)	2048x1080	24p/23.98p	50Mbps (YUV4:2:2/XHQ)	LPCM 2ch 48kHz/16bit	145 min.	
		1920x1080	59.94p/59.94i/50p/50i/29.97p/25p/23.98p	50Mbps (YUV4:2:2/XHQ)			
			59.94p/59.94i/50p/50i/29.97p/25p/23.98p	35Mbps (UHQ)			
		1280x720	59.94p/50p	35Mbps (UHQ)			
HD	AVCHD	1920x1080	59.94p/50p	28Mbps (HQ)	Dolby Digital 2ch 48kHz/16bit 256kbps	270 min.	
			59.94i/50i	24Mbps (HQ), 18Mbps (SP)		312 min./400 min.	
SD	QuickTime	720x480 (U model)	59.94i	8Mbps (HQ)	LPCM 2ch 48kHz/16bit 256kbps	760 min.	
	AVCHD					Dolby Digital 2ch 48kHz/16bit 256kbps	842 min.
	QuickTime	720x576 (E/EC model)	50i	8Mbps (HQ)	LPCM 2ch 48kHz/16bit 256kbps	760 min.	
	AVCHD					Dolby Digital 2ch 48kHz/16bit 256kbps	842 min.
WEB (Proxy)	QuickTime (MPEG-4, AVC/H.264)	960x540	29.97p/25p/23.98p	3Mbps (HQ)	μ -law 2ch 16kHz	2160 min.	
		720x480	59.94i	8Mbps		LPCM 2ch 48kHz/16bit	760 min.
		720x576	50i	8Mbps		LPCM 2ch 48kHz/16bit	760 min.
	AVCHD	480x270	29.97p/25p/23.98p	1.2Mbps (LP)	μ -law 2ch 16kHz	4720 min.	
		1440x1080	59.94i/50i	9Mbps (LP), 5Mbps (EP)		Dolby Digital 2ch 48kHz/16bit 256kbps	760 min./1344 min.
		720x480	59.94i	8Mbps			760 min.
High-Speed	QuickTime (MPEG-4, AVC/H.264)	1920x1080	120fps	59.94p/29.97p/23.98p	50Mbps (XHQ), 35Mbps (UHQ)	—	(Differs by setting)
			100fps	50p/25p			
			60fps	29.97p/23.98p			
			50fps	25p			
			50fps	25p			
4K EXT*	HDMI	3840x2160	59.94p/50p	Recording not possible with GY-LS300CH	—	—	

* Recording with supported recorder

Product and company names mentioned here are trademarks or registered trademarks of their respective owners. "AVCHD Progressive" and "AVCHD Progressive" logo are trademarks of Panasonic Corporation and Sony Corporation. HDMI, the HDMI logo and High-Definition Multimedia Interface are trademarks or registered trademarks of HDMI Licensing LLC. Dolby is a trademark of Dolby Laboratories. Zixi and the Zixi logo are trademarks of Zixi LLC. The SD, SDHC and SDXC are trademarks of the SD Card Association.

Simulated pictures.
The values for weight and dimensions are approximate.
E.&O.E. Design and specifications subject to change without notice.
Copyright © 2017, JVCケンウッド Corporation. All Rights Reserved.

JVCケンウッド

DISTRIBUTED BY